



# USER MANUAL

## INDUSTRIAL RANGE

PRANA 340S

● recuperators



Use the QR code or visit the website:  
<http://prana.help/b22> to overview useful information about the product.

- Some content and functionality may vary from device to device depending on the model, region, or software version, and are subject to change without notice.
- Read all safety information carefully to ensure safe and proper use of the device.

Before using and installing the product read the user's manual carefully.

After reading the user manual, keep it for as long as you use the product and be sure to provide the user manual when passing the control to another user.

## CONTENTS

---

WARNINGS AND SAFETY MEASURES .....	4
SYSTEM CONFIGURATION .....	8
DESCRIPTION OF THE REMOTE CONTROL .....	10
DESCRIPTION OF THE WINE CONTROL UNIT .....	11
MOBILE APPLICATION .....	12
DESCRIPTION OF THE TABS OF THE MOBILE APP .....	14
CHOICE OF RECUPERATOR .....	15
SYSTEM MANAGEMENT .....	16
CONTROL .....	18
PASSIVE OPERATION MODE .....	20
UNFREEZE FUNCTION .....	20
BRIGHTNESS CONTROL .....	20
MANUAL OPERATION .....	21
SEPARATE CONTROL MODE .....	21
MINIMUM MODE .....	22
VENTILATION MODE .....	22
SLEEP TIMER MODE .....	23
DATE AND TIME MODE .....	23
MINI-HEATING MODE .....	24
WINTER MODE .....	24
DEVICE UPDATE AND SOFTWARE .....	25
SENSORS INDICATORS .....	26
PROGRAMMED CONTROL .....	28
PROGRAMMED CONTROL FUNCTION .....	29
STATISTICS AND GRAPHS ACCOUNT .....	31
ACCOUNT .....	32
DC CONSOLE MALFUNCTION .....	34
BATTERY REPLACEMENT REMOTE DC .....	36
CLEANING THE CONTACTS OF THE REMOTE CONTROL ...	37
AIR DUCT MAINTENANCE .....	38
VENTILATION SYSTEM MAINTENANCE .....	39

## WARNINGS AND SAFETY MEASURES

---

- This appliance can be used by children aged from 8 years and above, people with reduced physical, sensory or mental capabilities or with lack of experience and knowledge as long as they are supervised or instructed on the safe use of the device and understand the hazards involved. Do not allow children to play with the unit.

Servicing and mounting of the system should not be performed by kids. The system has to be installed in places which are excluding kids acces.

- Asphyxiation danger. The appliance may contain small parts. Some of these small parts may need to be disassembled during the cleaning and operation maintenance. Be careful and keep small parts out of the reach of children.

- Unqualified users must not install, move, disassemble, modify or repair the recuperator by themselves. Begore the use make sure that the installation complies with the mechanical and electrical regulations which are in force in the country where the installation was carried out.

- The presence of excessive windage can affect the performance of the system.

- Do not block the intake or exhaust air passages as this will reduce the performance of the system.

- The manufacturer is not responsible for the installation that is carried out by an unqualified specialist (or group of specialists) and all subsequent consequences connected with it. Incorrect installation will invalidate the warranty.

- The fan inside the device rotates during operation. Avoid putting foreign objects inside the device during operation. Doing so may result in personal injury.

- Maintenance of the product should only be performed by a suitably qualified person with the appropriate level of electrical safety clearance who is familiar with the user manual.

- The power supply voltage must be supplied through a switch that disconnects all supply phases in accordance with wiring regulations. Do not operate the product without grounding.

- Before carrying out any maintaining operations, it is necessary to de-energize the unit (unplug it or turn off the main power switch and wait for the fans to stop completely).

- Do not dispose the ventilation system with household waste at the end of its useful life. Dispose of the unit at the appropriate collection points provided in your country.

- When connecting the product to the mains do not use damaged equipment and wires. If there is any extraneous noise, odor, or smoke, immediately turn off the power with the circuit breaker.

Continued use of the product can cause smoke, fire, electric shock or injury. Contact the manufacturer's service center or dealer in your area for repairs.

- The air ducts must be equipped with grills or other device preventing free access to the fans.

- Do not locate the junction box at the lowest point of the product to prevent condensation and risk of shorting. Do not expose the product to water. Do not install or maintain the product with wet hands.

Always keep the conductive parts of the network dry, insulated and inaccessible in order to prevent accidents or short-circuits in the network.

- To avoid reverse draught in rooms where fireplaces, gas heaters and other equipment producing or different gas mixtures are in operation, the «Separate control» mode must not be used.

- When using the system with other ventilation systems in operation in the same room, the performance of the unit may differ.

- Use the product only for its intended use.

- When using the system with other ventilation systems in operation in the same room, the performance of the unit may differ.

- The air being conveyed must not contain inflammable or explosive mixtures, chemically active vapors, sticky substances, fibrous materials, coarse dust, soot, grease, or media that promote the formation of harmful substances (poison, dust, pathogenic microorganisms).

- Do not block the condensate drain, as this may cause equipment failure and water ingress into the room.

- The manufacturer declines responsibility for possible damage directly or indirectly caused by the ventilation system to people, animals, property if it is caused by failure of observing the operating rules and conditions, product adjustment, intentional or negligent actions of the buyer (user) or third parties.

## SYSTEM CONFIGURATION

---

The availability of certain functions and capabilities depends on the configuration of your recuperator.

PARAMETER	** A	** H	** WA	** WH
Wall version	-	-	+	+
Mini-heating	-**	-**	+	+
Winter mode	-**	-**	+	+
Heating element control	-	+	-	+
Date and time	+	+	+	+
Bluetooth support	+	+	+	+
Wi-Fi support*	-	-	-	-
Air quality sensors*	-	-	-	-
Operation modes* AUTO and AUTO+	-	-	-	-

\* The control interfaces are provided with extended functionality similar to the household series. Samples of the industrial range are currently being tested.



The letter designation of the ventilation systems configuration:

\*\*A - ventilation system is equipped with a control unit in a dust-proof enclosure;

\*\*H - ventilation system is equipped with a control unit in a dustproof enclosure with the possibility of connecting and controlling a supply air after-heating heater;

\*\* WA - wall ventilation system equipped with a control unit in dust-proof enclosure and mini-heating foil;

\*\* WH - wall ventilation system equipped with a control unit in dust-proof housing and mini-heating foil with the possibility of connecting and controlling a supply air afterheating fan;

## DESCRIPTION OF THE REMOTE CONTROL

---

The graphic below shows the appearance of the remote control.

Purpose of the remote control buttons.

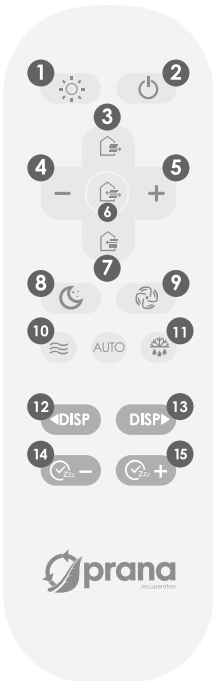

- 1 - Display brightness adjustment
- 2 - Switch off
- 3 - Extract control
- 4 - Reduced speed
- 5 - Increase speed
- 6 - Simultaneous flow control
- 7 - Tide control
- 8 - Minimum mode
- 9 - Mode «Ventilation».
- 10 - ON/OFF «Mini-heating» function\*.
- 11 - «Winter mode» function
- 12,13 - Page through additional menu
- 14,15 - «Sleep Timer» function

\* The functioning of the buttons may vary and depends on the system configurations. Details are described in this manual for each function or mode of operation.

## DESCRIPTION OF THE WINE CONTROL UNIT

---

The graphic below shows the appearance of the controls.

Purpose of the control buttons.



- 1 - Information panel
- 2 - ON/OFF «Mini-heating»\*
- 3 - «Winter mode\*» function
- 4 - Sleep timer function
- 5 - Inflow speed control
- 6 - Exhaust speed adjustment

\* The function of the buttons may vary depending on the configuration of the system, details are described in this manual for each function or operating mode.

## MOBILE APPLICATION

---

Turn on the PRANA ventilation system.

Use Google Play (Android) or the App Store (iOS) to download the PRANA Online app.

Or use the QR code below:



Launch the mobile app.

The Bluetooth and GPS (geolocation) functions in your device may turn on automatically.

If not, enable them yourself and restart the app.

Without this permission, our app cannot enable the search.

The bottom list after the search will place all PRANA ventilation systems under the following conditions:

- They are enabled.
- Have a built-in Bluetooth module
- Are in range of its network

Select a device from the list, its name by PRANA Recuperator by default and the password is 0000.

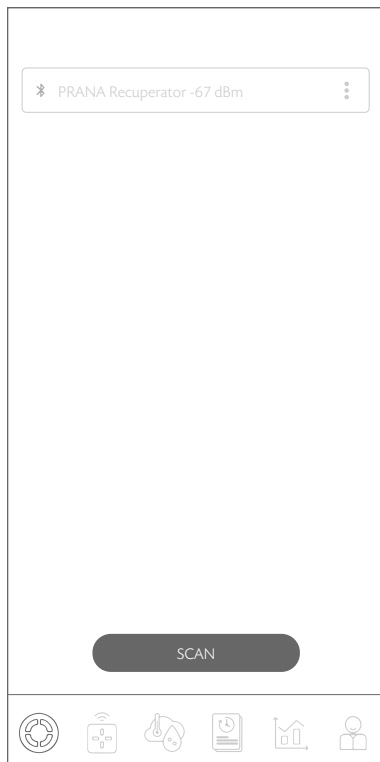

Select the Bluetooth connection method (for the initial connection) and press the «Connect» button.

You can then control the system (recuperator) PRANA.

## DESCRIPTION OF THE TABS OF THE MOBILE APP

---

Below is a description of the tabs of the PRANA ONLINE mobile application as a component of the ecosystem (service).



Image «Menu of tabs» of the PRANA ONLINE mobile application.



- Selecting the recuperator



- Management



- Sensor readings (TEST)



- Programmable control (TEST)



- Statistics (TEST)



- Account.

## SELECTING THE RECUPERATOR

---

The contents of the tab are shown graphically below.

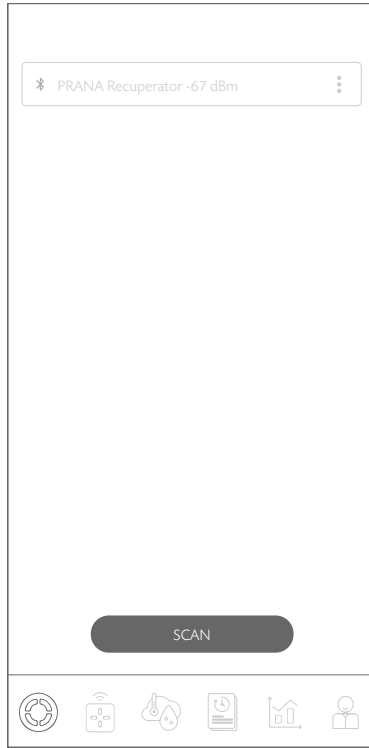

The tab allows you to select the management system, give a name, change the name, change the password, set the connection method, connect to the storage and delete the device.

## SYSTEM MANAGEMENT

---

For ease of use (if there are 2 or more systems) you can assign each system an individual name and password to access it.

All further actions take place on the tab «Select Recuperator».

To rename the system, press **⋮** next to the system you are currently connected to, select «Rename»; use the keyboard to enter the desired system name and press «SAVE».

The system will reboot and change.

To change the system password, press **⋮** next to the system you are currently connected to and select «Change password»; use the keypad to enter the password (four digits) and press «SAVE».

The system will reboot and change.

SCAN button - allows you to update the list of available systems on the network by searching through Bluetooth.

Later in the list of available systems you will see the individual names of your systems and manage them.

Be sure to write down the password so that you do not lose access to the system and statistics.

If a situation occurs where the password to the system were lost or forgotten, you can reset it to the factory state with the



combination on the remote control (if you reset the password to the factory value, the statistics data may be lost):

2x  2x  2x  2x 

If all done correctly, the system display will show RESET.

Parameters that will assume the factory state:

- The system name will assume the factory value: PRANA Recuperator;
- The system password will be set to factory default: 0000;
- The statistics and the list of programmable control can be deleted.

If you are interested in connection by using the Internet (Wi-Fi module), refer to «Account» section.

# CONTROL

---

The contents of the tab are shown graphically below.

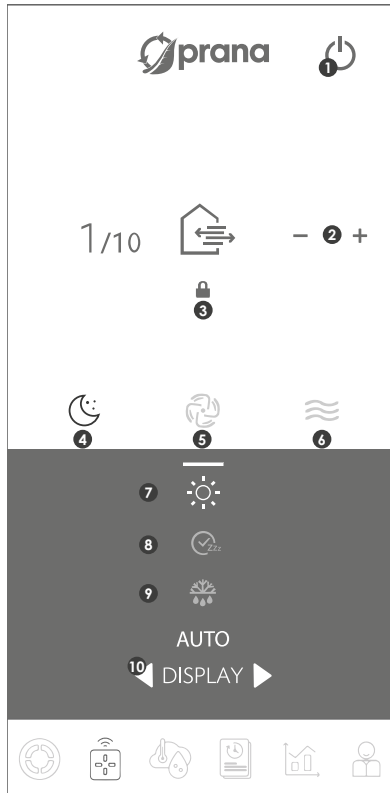

The tab allows you to control the selected system, change motor speeds, set operating modes and use the functions of the mobile app.

Purpose of the Control tab buttons.

1 - Turning Off

2 - Manual control of air streams

3 - Separate airflow control

4 - Minimal mode

5 - «Air current» mode

6 - Mini-heat function

7 - Dimming the brightness of the display

8 - «Sleep Timer» function

9 - «Winter mode» function\*.

10 - Scroll through additional menu\*.

\* The function of the buttons may vary depending on the system configuration, details are described in this manual for each function or mode.

The air flows can be controlled separately from by the mobile app. Overlook «Separate control mode» for more information on this mode.

## PASSIVE OPERATION MODE

---

Passive mode is the operation of the recuperator when motors are switched off.

It consists in movement of uncontrolled air flows through the recuperator.

This is done by the difference of pressure and temperature inside and outside the room.

## UNFREEZE FUNCTION

---

During the cold period in case of improper operation of the wall or combined heat exchanger there is a risk of icing of the heat exchanger, which leads to: a significant reduction in efficiency, accumulation of condensate in the system, icing of the motors.

If icing occurs, it is necessary to:



1. Switch on recuperator;
2. Turn off tide and exhaust;
3. Turn on the «Mini-heating» function;
4. Wait 60 minutes for its sizing.

Then turn on the recuperator in the desired operating mode. If the situation does not improve, this method should be repeated.

## BRIGHTNESS CONTROL

---

We have provided 6 levels of display brightness to ensure comfortable operation of the system.



The brightness of the display can be adjusted with the  button on the remote control or  in the mobile app.

## MANUAL OPERATION

---

Manual mode is used as the default operating mode. The performance of the system changes in 10% increments.

The speed modes are switched with the +/- buttons on the remote control or in the mobile app.



You can switch the system of simultaneous streams control by pressing 2x  on the remote control or  in the mobile app.

## SEPARATE CONTROL MODE



---

The function allows you to control the inflow air and exhaust air flows separately.

The mode of the supply and exhaust air volume can be seen in the mobile app and in the information panel as the corresponding value from 1 to 10.

To control the airflow from the remote control, press the  supply or  exhaust button, and then set the desired air volume with the +/- buttons.

To control the airflow from the mobile app, press the  button, then set the desired airflow volume with the +/- buttons, where the airflow values are at the top and the exhaust values are at the bottom.



To control the airflow from the remote control, press the + or - on the inflow control  or on the exhaust control .

## MINIMUM MODE

---

«SUP1, EXT1» on the information panel - the system operates in «Minimal» mode.

Minimal is the quietest mode of the system, designed to work at night or when there is no need for more air exchange.

It is activated by a button  on the remote control or by the button  in the mobile application.



On the remote control unit by setting the inflow and exhaust to 1.

## VENTILATION MODE

---

«SUP10, EXT10» on the information panel - the system operates in «Ventilation» mode.

Maximum operating mode of the ventilation system.



The «Ventilation» mode is activated with the button  on the remote control or the button  in the mobile application.





On the remote control unit by setting the inflow and exhaust to value 10.

## SLEEP TIMER MODE

---

On the display panel - the selected time of the set sleep timer is displayed.

The function is activated with the  button on the remote unit. Switching the timer configuration is set with the controller button  on the remote control unit.

The function is activated with the  button on the remote control. Use the   buttons on the remote control to switch the timer configuration. The function is activated with the  button on the mobile app.

Press the +/- buttons on the mobile app to switch the timer configuration. When the selected time has elapsed, the system will automatically switch to standby.

There are 9 default configurations of the timer. When selecting a timer configuration, the display panel indicates the selected mode with numbers from 1 to 9.

Timer configurations:

- 10 min • 20 min • 30 min • 1 h • 1 h 30min •
- 2 h • 3 h • 5 h • 9 h •

## DATE AND TIME MODE

---

For additional comfort, the control units have a date and time function.



The function is activated via an additional menu. The control unit receives the date and time from a smartphone when synchronizing via Bluetooth.

When disconnecting the control unit from the network, synchronize again.

## MINI-HEATING MODE

---

When the outdoor temperature is below 4 °C, in order to prevent the heat exchanger from freezing and the condensate escape route, the system must be operated with the «Mini-heating»\* and «Winter mode»\* activated.

The function is activated by pressing  on the remote control  in the mobile app or  on the control unit.



\* The availability of the function depends on the system configuration, details are described in this manual.

## WINTER MODE

---

The «Winter mode» function is designed to ensure the correct operation of the system during the cold season.

To ensure correct operation - the use of «Winter mode» and «Mini-heating» function is mandatory when the outside temperature is lower than +4°C.

The function is activated by pressing  on the remote  in the mobile app or  on the control unit, then select the desired mode of ventilation system operation.

After the time on the timer «Winter mode» expires (5 min), the ventilation system will start in the selected operating mode. The motors of the ventilation system will only start after the «Winter mode» timer has elapsed.

After the system is switched off, the «Winter mode» will run for an additional 30 minutes to prevent icing in the system, which could result in reduced efficiency or complications with condensate drainage.

\* The availability of the function depends on the system configuration, details are described in this manual.



Some content and functionality may differ from your device depending on the model, region or software version is subject to change without notice.

PRANA Recuperator is a device that is controlled from a smartphone, so the operation of some functions may be subject to changes after the update.

Some items in this manual may not be relevant if the software is updated.

You can always consult the updated instructions at the following link:

([prana.help/b22](http://prana.help/b22)).

You can also ask for help from the warranty card can be found in the data sheet of the product.

PRANA is not responsible for the fact that the customer was not able to use the PRANA ONLINE services on their devices and/or does not use them correctly.

This is due to the large number of manufacturers of multimedia devices for which it may take some time to adapt the services.

## SENSORS INDICATORS (TEST)

---

The contents of the tab are shown graphically below.

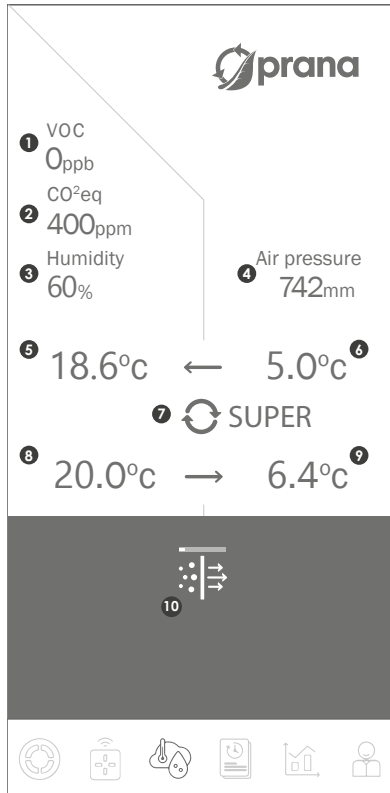

The information from the sensors can be checked in real time.

The function is in the testing phase. Sometimes errors in operation may occur.

The availability of certain sensor values depends on the configuration of your recuperator.

Correspondence of «Sensor Indicators» values.

1 - Air quality index, TVOC

2 - Carbon dioxide equivalent level, CO<sup>2</sup>eq

3 - Relative humidity, Rh%

4 - Atmospheric pressure, mm Hg.

5 - Tidal air after recuperation, °C

6 - Tidal air to recuperation, °C

7 - Approximate efficiency factor

8 - Extract air before recuperation, °C

9 - Extract air after recuperation, °C

10 - Filter clogging indicator

In addition to viewing the data in real time, these indicators are used to build graphs and displayed in the statistics.

The statistics are only collected via the internet connection and are stored in the storage.

If you are interested in the connection via Internet connection (Wi-Fi module), please refer to the «Account» section.

## PROGRAMMED CONTROL (TEST)

---

The contents of the tab are shown graphically below.

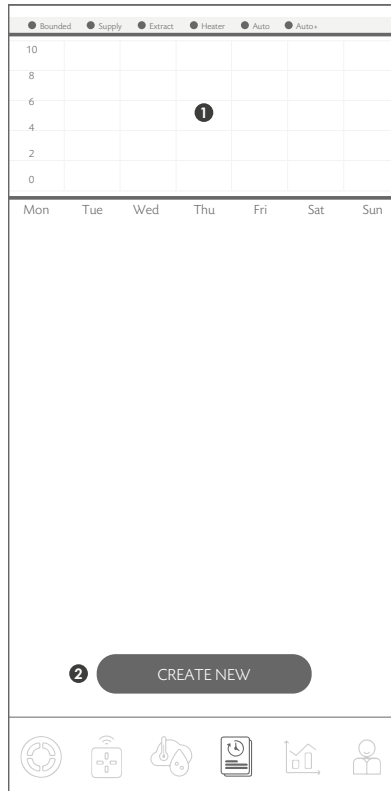

Operation of the system by schedule. Ability to select the modes of operation on certain days and time intervals.

The function is at the testing stage. Sometimes errors in operation may occur.

1 - Visual representation of the programmed operating modes.

2 - Button allows you to create a new rule for schedule operation.

## PROGRAMMED CONTROL FUNCTION (TEST)

---

The function allows you to pre-program the operating mode of the recuperator at certain time intervals.

The function is in the testing phase. Sometimes errors may occur in the operation.

To create a new rule, click Create new.

In the «Start» field, select the day of the week and the start time of the event. If you want the event to recur every day, select «Everyday».

In the «Finish» field, select the day of the week when the event ends. If you select «Everyday» in the «Start» box, the event will end every day.

After entering the time frame, select the function or operating mode in which the system (recuperator) should operate during that time.

After the rule is finished, the system (Recuperator) will return to the previous operation mode.

If you want to delete a rule, press  of the desired rule and select «Delete».

If you want to change a rule, press  near the desired rule and select «Edit». Then make the changes and select SAVE to save them.

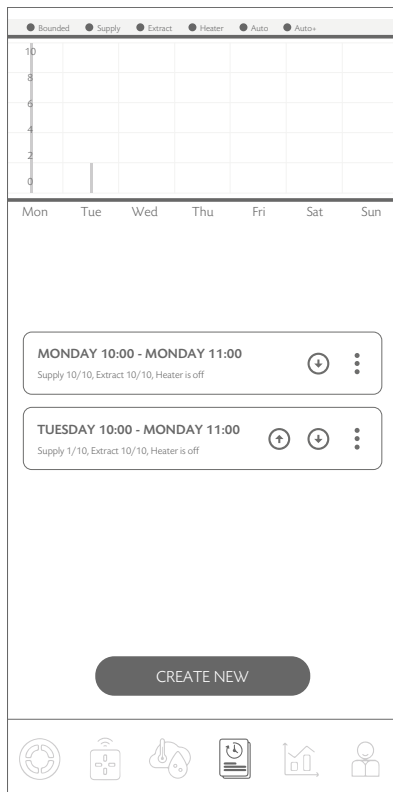
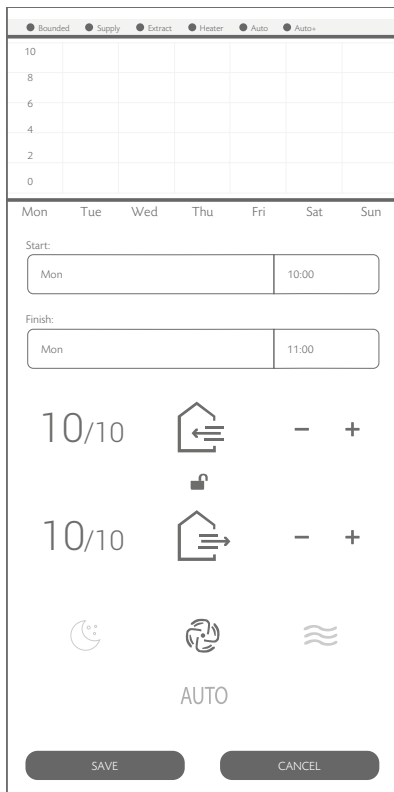

If you have created several rules, the first one above will be executed first.

After creating rules, you can set the priority with the navigation buttons: ⬆️⬆️

By raising the more important rules and dropping less important ones, you can set up different combinations of their interactions.

The contents of the tab are shown graphically below.

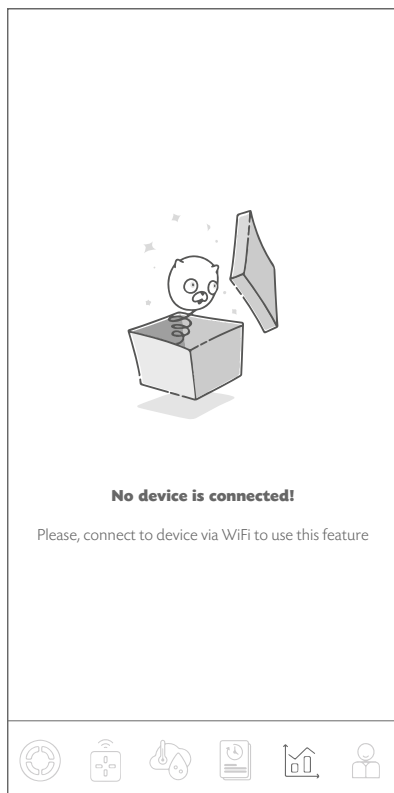

Ability to view the indicators from the system sensors at different time intervals.

The function is in the testing phase. Sometimes errors in operation can occur.

Statistics is displayed and saved only when connected via Internet connection (Wi-Fi module in the system). For details, see the «Account» section.

The contents of the tab are shown graphically below.

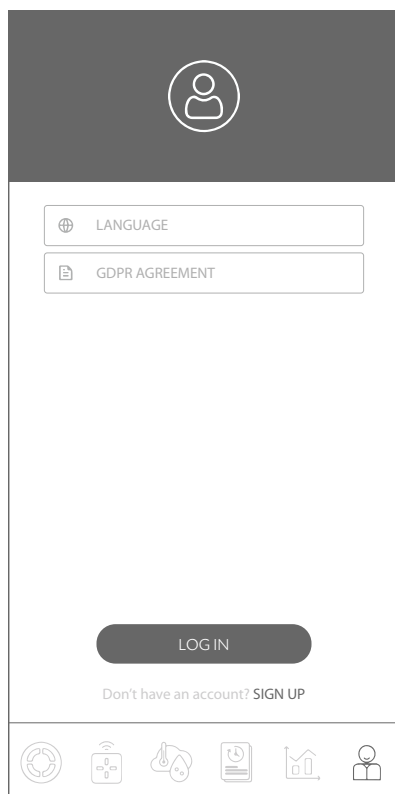

This tab allows you to register and/or authorize in the «PRANA ONLINE» service.

The tab also allows you to read the «GDPR AGREEMENT» policy and select the interface language.

In some PRANA ventilation systems, in addition to the Bluetooth control method, there is a control with Internet connection use\* (the system can be equipped with a Wi-Fi module\*).

\* In the system configuration section you can see if this module is available in your model.



The Quick Start Guide describes how to connect using Bluetooth. Registration and authorization is required only if you collect statistics for future viewing and control via the Internet service «PRANA ONLINE».

The standard set of functions will work without PRANA ONLINE service, but by using a mobile application (via Bluetooth), remote control, remote control unit, and statistics from the recuperator is not transferred to the storage. The systems connected to account, have the ability to automatically update the software.

With the help of updates we:

- Fix bugs
- Expand and improve functionality
- Optimize memory usage allowing the system to run faster and more efficiently.

If you're interested in connecting using Wi-Fi, see the «Supplement to the User's Guide» document. To download the manual, visit the website ([prana.help/b22](http://prana.help/b22)) and select your model and version of recuperator.

To connect using an internet connection in any case requires:

- Make the initial connection via Bluetooth.

There must be a Wi-Fi access point in your room. (2.4GHz), with internet access.

- Access to the router settings.

## DC CONSOLE MALFUNCTION

---

If a malfunction of the remote control occurs during operation, follow the steps in this manual.

The images show the back side of the remote control.

- Press on the ribbed part of the back cover.

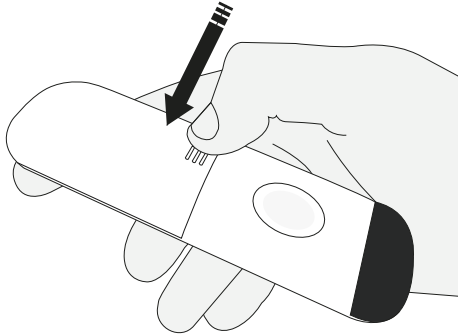

- Slide the cover outside of the remote control.

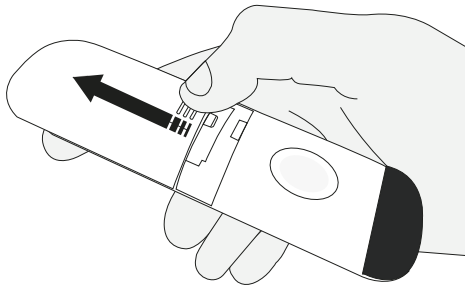

- Rotate the batteries around their axis (as shown in the illustration) and check for visual traces of soiling.

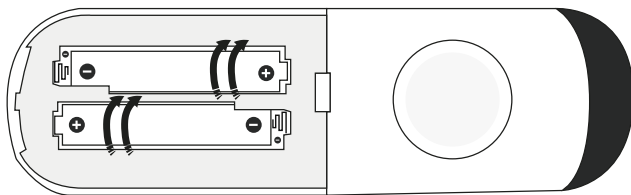

The type of batteries used in the remote control is AAA/R03/1.5V.

- If the batteries are missing, proceed to install the batteries (see «Replacing the Remote Control Batteries» for instructions on installing and removing the batteries).
- If the remote control does not work (or the batteries are visually dirty), proceed to «Cleaning the remote control contacts».
- If there is no visual soiling but the batteries do not work, proceed to «Replacing the Remote Control Batteries».

## BATTERY REPLACEMENT REMOTE DC

---

- Remove the used batteries.

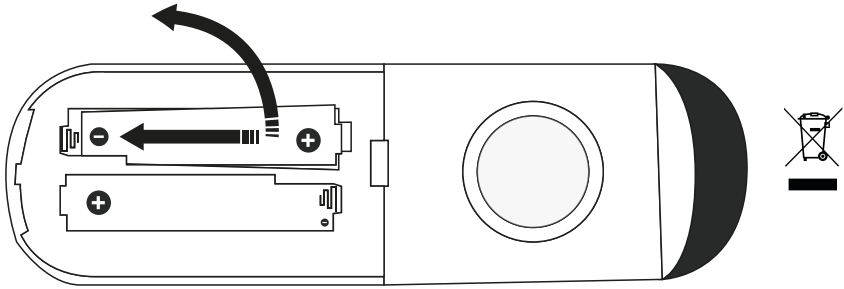

- Insert new batteries, making sure that the «+» and «-» polarities indicated in the compartment.  
Insert the batteries starting on the «-» side.

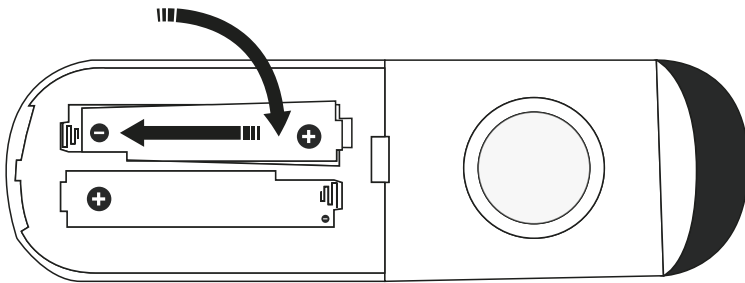

- Place the back cover on the remote control, push it all the way in and make sure the cover is in its original position.

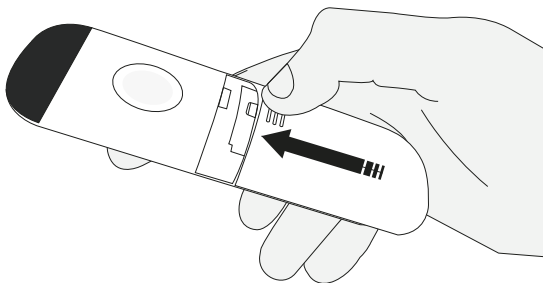

## CLEANING THE CONTACTS OF THE REMOTE CONTROL

---

Clean the contacts of the remote control with a small amount of special cleaning agent (e.g: KONTAKT 60) using a cotton swab, cotton swab or soft cloth.

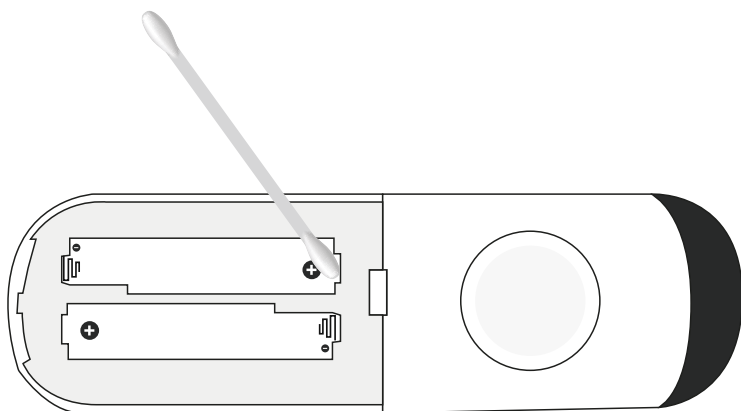

If the remote control does not work after the operations performed (cleaning of the remote control contacts, replacement of the batteries), contact the service center of the manufacturer or dealer in your area.

The dealer's contacts can be found in the warranty card (the warranty card can be found in the product datasheet).

- Dispose of used batteries according to local rules and regulations.
- Do not use new batteries together with old ones or different types of batteries.
  - Do not use an accumulator instead of batteries.
  - For the new PRANA system, batteries are included. They must be installed in the remote control before they can be used.

## AIR DUCT MAINTENANCE

---

During operation of the ventilation system, elements of the network can become dirty. It is necessary to service the network by cleaning each of the elements.

1. Maintenance of exhaust and tidal air diffusers and louvers (if necessary):

1.1 Remove the diffusers and louvers and wash them with a warm solution of neutral detergent.

2. Maintenance of external air intake and exhaust grilles (twice a year).

2.1 Leaves and other debris can clog the outdoor air intake grille and reduce the performance of the unit and the amount of supply air.

Check the outside grille twice a year and clean if necessary.

3. Maintenance of the duct system (every 5 years).

3.1 Even if all the maintenance operations mentioned above are performed regularly, dust deposits can accumulate inside the ductwork, resulting in reduced performance of the ventilation system.

Maintenance of the air ducts consists in their periodic cleaning or replacement. Dirty filters increase the air resistance in it, for this reason, less air enters the less air enters the room.

4. It is recommended that the filter be changed to a new one every 6 months, or more frequently, depending on the quality of the air environment passing through the filter.

## VENTILATION SYSTEM MAINTENANCE

---

Maintenance consists of inspecting, if necessary, cleaning surfaces and checking the electrical components of the ventilation system.

Observe safety rules when carrying out maintenance or repair work.

Before starting maintenance or repair work make sure that the ventilation system and accessories are disconnected from the power supply.

Do not carry out maintenance or repair work until you have ensured that all mechanical movement in the ventilator has stopped.

Sequence of operations when disassembling/assembling the ventilation system:

1. Remove the cover from the junction box.
2. Using a multi-tester, check the capacitors for deviations from the nominal value (capacity and % of possible deviations are indicated on the capacitor housing).
3. Loosen the screws around the motor (on the side of the junction box).
4. Remove the top cover of the motor.
5. In the junction box, bite off the plastic clips fixing the wire to the housing.
6. Unscrew the screws fixing the «wing» on which the motor is located.
7. Remove the motor.
8. The same procedure is performed on the other side (with the other motor).

9. Carefully inspect the fan blades. Covering with dust or other materials can imbalance the fan blades. This causes vibration and accelerates wear of the motor bearings.

10. Check for contaminants in the air passages of the recuperator and each item to be disassembled (including side screens of recuperator).

11. Clean (dry) and reassemble the system in the reverse order. For the sake of convenience and efficiency cleaning may be done with a vacuum cleaner.

12. If necessary clean the branch pipe of the condensate drain. Diameter of the branch pipe is 6 mm.

Note: This sequence of operations is described for superficial cleaning and inspection.

For a more detailed inspection and cleaning, we recommend contacting the retailer/contractor or an organization qualified in carrying out such work.









